

Installation, Care and Maintenance Instructions

Congratulations and thank you for your purchase of a 64Door Factory Interior Door Set. The following document will guide you through the installation and maintenance process of the interior door set, please keep it for future reference. Following the care and maintenance conditions will make sure that your Interior Door Set will keep its look and function for years to come. 64Door Factory gives a 1 year guarantee on all doors that we produce. There is an additional 1 year guarantee if installation of your door set is done by an authorized 64Door Factory technician. The guarantee covers material and manufacturing defects. The guarantee only covers material and manufacturing defects. The guarantee does not cover natural wear or defects from installation flaws where installation is not done by 64Door Factory.

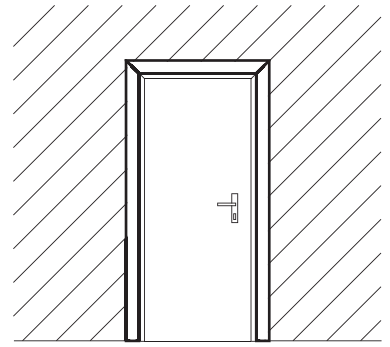

Usage and Storage

The interior door set is meant for indoor use only. The door set should not be stored in places, where the range of temperature and relative humidity fluctuation is extensive. Recommended storage area would be in a dry, well ventilated building. High moisture environments can harm the door set and should be avoided at all costs.

When stacking the door set for storage, the surface should be smooth and horizontally level. The stack should be on at least three support beams, so that the weight of the door is divided equally. This helps avoid damage to the door set. The door sets should not be stored under direct sunlight, as it may cause the color of the doors to deteriorate. When the doors are stored

or installed in a construction environment, the packaging should be kept intact as long as possible to avoid potential damage to the doors. The interior door set is not suitable for use in outside conditions and between rooms that have a considerable difference in temperature. The interior door set is not meant to endure long periods of immense temperatures, high humidity environments, nor water.

Interior Door Maintenance Instructions

The interior door set is meant for interior use only: hallways, work or living areas. Modifying the sizing of the door or cutting it in anyway is not permitted. If modifications are required, contact 64Door Factory for instructions. Occasionally ensure that the locks,

hinges and handles are in working condition. If needed, tighten screws or replace worn out components for new ones. If required, at least once a year lubricate the locks and hinges with oils that contain Teflon. When oiling, make sure not to spill oil on the surface areas of the door set.

For cleaning the door use a moist and soft cloth. For more stubborn dirt, use household cleaning supplies (non-solvents). Glass surfaces can be cleaned with all household cleaning supplies. Make sure that the cleaning supply does not contain any solvents by reading the label.

Allowable Defects

- > According to the European door standards the acceptable curvature of the door leaf and door frame is 3mm per 1m.
- > The differences of the diagonals of the door sheet might differ up to 3mm.



64 DOOR FACTORY

www.64door.com
info.ke@64door.com

Ke: +254 20 200 2009
Tz: +255 677 88 88 55

Installation Guide - Interior Door Set

Parts Included

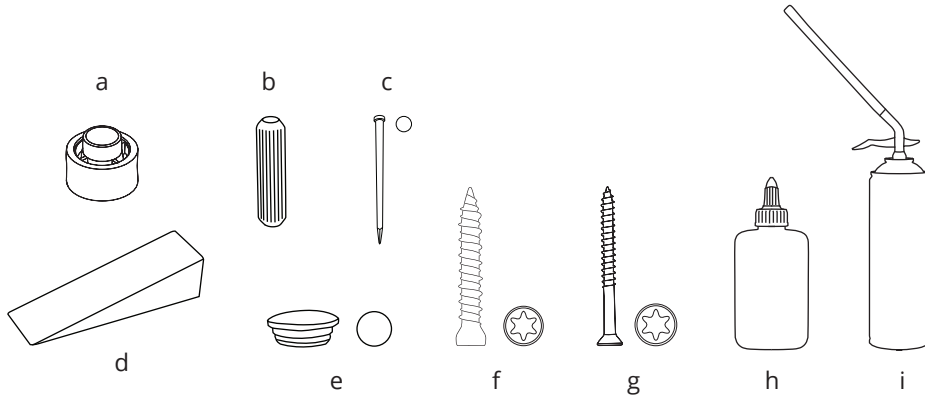

- a. Distance spacers for wide gaps x4pcs
- b. Wooden dowels x 4pcs
- c. Beading nails (1.4 x 3mm)
- d. Wooden wedges x 12pcs
- e. Cover caps x 4pcs
- f. Adjufix concrete screws (7.5x70mm)
- g. Wood screws (5x70mm) x2pcs (regular door) & 4pcs (fanlight door)
- h. Glue
- i. Foam with applicator (straw)

Recommended Tools

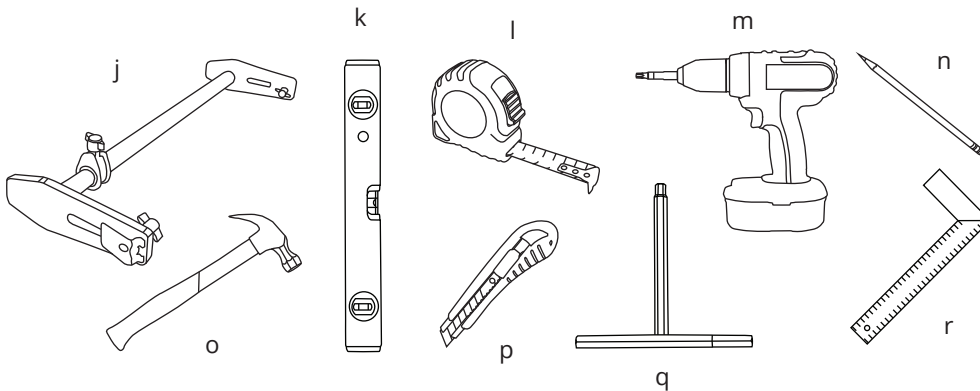

- j. Door frame Clamp x2pcs
- k. Spirit level
- l. Measuring tape
- m. Drill + Torx 20, 25, 30
- n. Pencil
- o. Hammer
- p. Stanley blade
- q. Allen keys
- r. Square

Instructions

Care should be taken when handling the door and help should be sought if necessary.

Make sure that the hinges, door leaf and frame are the right size and have no defects.

These instructions ought to be read and understood completely before any work commences:

1. Firstly, make sure that the door set fits the wall cavity you want to install it to. When measuring the wall cavity make sure it is horizontally and vertically levelled and that all the corners are right angles (90 degrees). If needed, adjust the wall cavity. Small imperfections may exist, although it might not lead to an ideal end result.

2. In case you are assembling a standard door, follow A. If you are assembling a vented door, follow B.

(A) Assemble the door frame with two (2) wooden dowel pins (b.) and two (2) screws (g.).

(B) First attach the glass/skin support frame with two (2) dowel pins (b.) and two (2) screws (g.). Then assemble the door frame with two (2) wooden dowel pins (b.) and two (2) screws (g.).

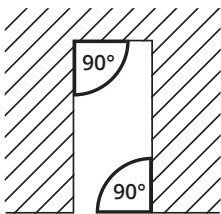

1.

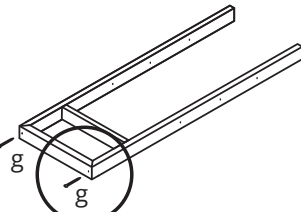
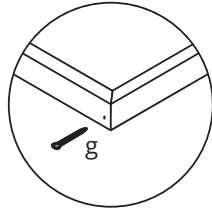
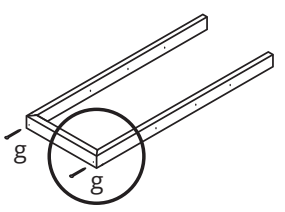
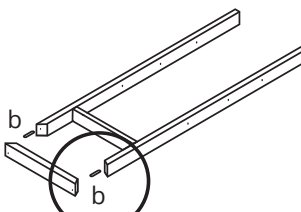
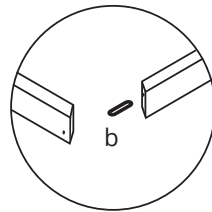
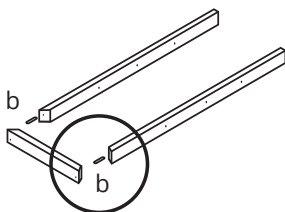
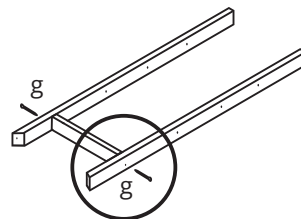
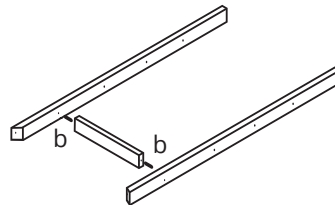
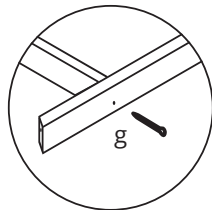

2.A

2.B

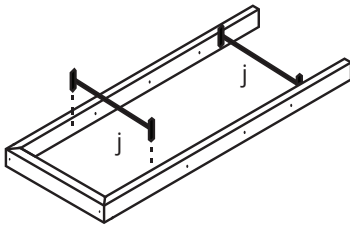

3.A

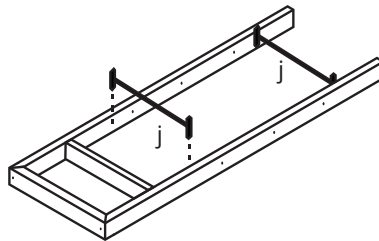

3.B

3. Fix two (2) door frame clamps (j.) on the frame. Make sure not to fix clamps in a way that covers or makes it difficult to access the holes on the frame.
4. Place outside of the door frame if necessary distance spacers (a.).
5. Bear in mind which way you want the door to open afterwards.
6. Secure the assembled door frame into the wall cavity. First fix the frame with wedges (from top). After that fix with adjufix and remove wedges (d.). To screw the adjufix sleeve use allen key (q.).
7. Install screws (f.) through the adjufix sleeve into the wall (not fully).

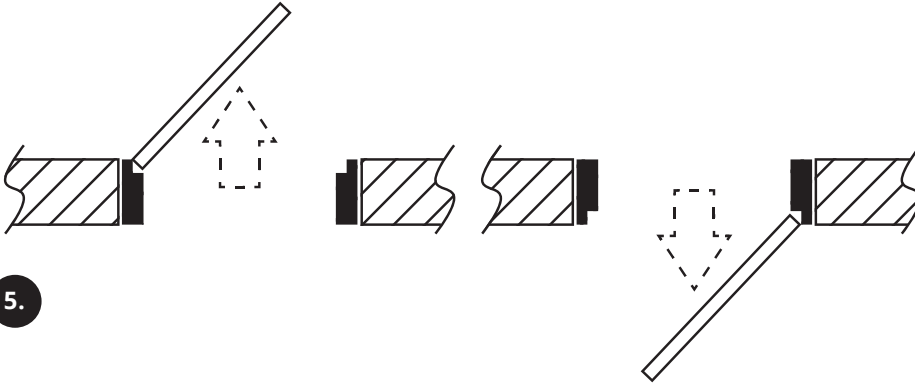

5.

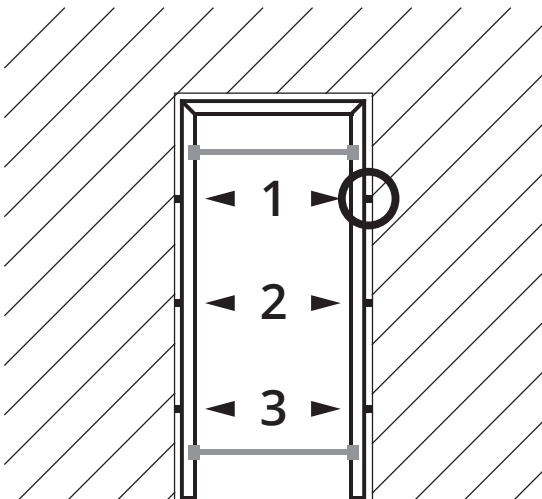

6.

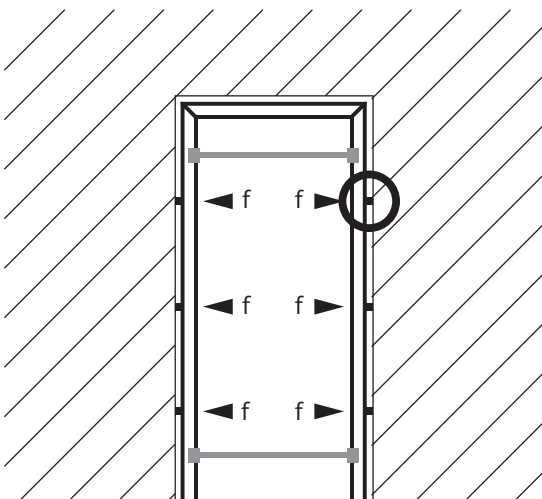
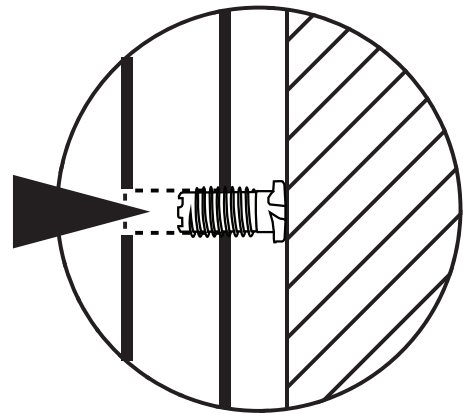

7.

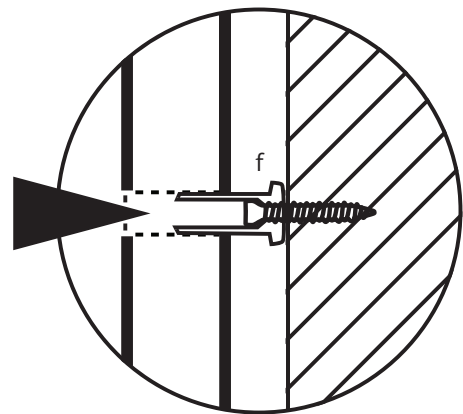

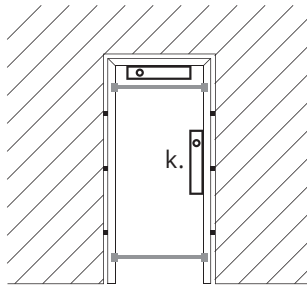
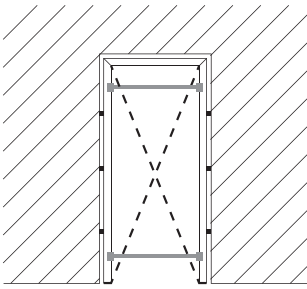

8.

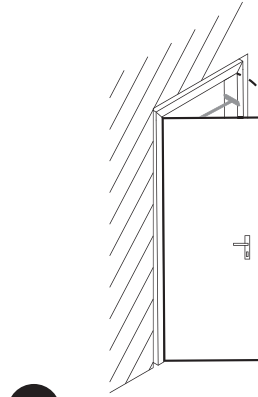
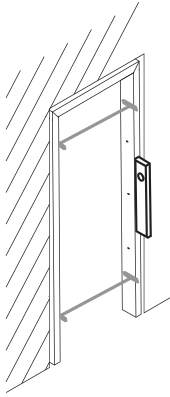

9.

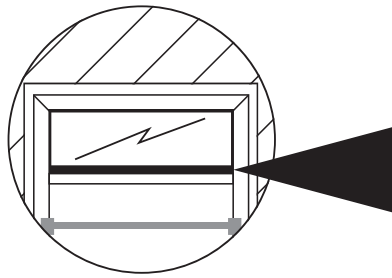
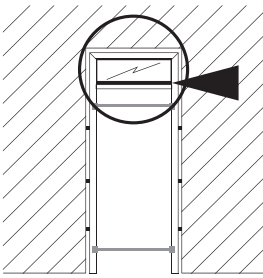

10.

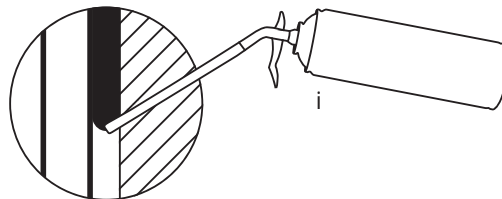
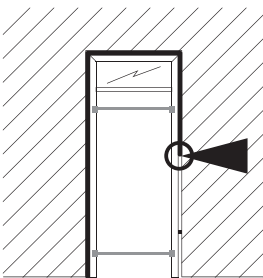

11.

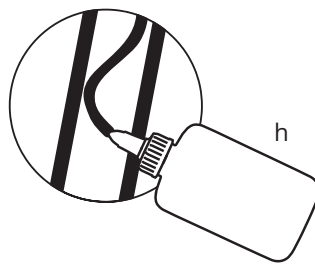
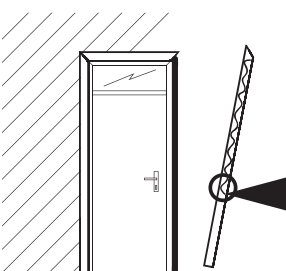

12.

8. Use a level tool (k.) to make sure that the frame is vertically level and the corners of the frame are right angles (90 degrees). For regulating the frame, start from the hinge side and use adjufix.

Before regulating, the adjufix should be fixed with screws (f.). After the hinge side of the frame is perfectly vertical, regulate the other side of the frame. The door panel and frame need to have equal distance between them from all places.

9. Make sure the door sheet can move freely and that the space between the door and the frame is equal on both sides. If needed tighten then frame screws or adjust the wedges.

10. In case you are installing a vented door then place the glass/skin on the glass support frame and secure it with the glass bond and beading nails (c.).

11. Fill the gap between the wall and the frame with foam (i.), makes sure to follow the instructions on the can. A Stanley knife (p.) with a flexible blade is perfect for cutting off excess foam. Apply finishing if essential, between the wall and frame, make sure it is done with non-corrosive materials.

12. Attach the architraves to the door frame. Make sure surfaces are clean, dry and free of dust. Apply glue (h.) to the back of the architrave and bring the surfaces together and manoeuvre it into position. Allow the adhesive to dry as instructed on the can.

Warranty

What this Warranty Covers

64Door Factory warrants, subject to the conditions and restrictions contained below, that each door, component part or door furniture manufactured and sold by 64Door Factory shall be free from defects in materials or workmanship for a period of one (1) year (for self-installations) and two (2) years (for 64Door Factory technician installations) from the date of purchase. This warranty extends to the original purchaser. The term "original purchaser" as used in this warranty means the contractor/distributor/exporter/dealer/purchaser and the initial owner of the structure into which the product is

installed. This warranty is not assignable or transferable. The original purchaser is responsible to assure that the initial owner of the structure into which the product is installed receives a copy of this warranty. The failure to provide the owner with this warranty will not subject 64Door Factory to any express or implied warranties, liabilities or remedies in excess of those provided herein.

Should any such product be proven defective during the warranty period, the buyer's remedies will be limited to the following at 64Door Factory option:

(1) repair of the defective product or component part (2) replacement of the defective product or component part or (3) reimbursement of the purchase price. These remedies are the only remedies available for breach of warranty or any other legal theory. In no event shall 64Door Factory, be responsible for installation, repainting, refinishing, or similar activities connected with the replacement of product or component parts. Execution of service and costs incurred for shipping, handling, transferring, insuring, transporting, and installing are the responsibility of the distributor, exporter, or dealer.

How to get Assistance

All claims must submitted by email to the following address:

Kenya: info.ke@64door.com

Tanzania: info.tz@64door.com

To initiate a claim under this warranty, contact 64Door Factory and if applicable the distributor, exporter, or dealer from

whom you purchased the 64Door Factory product. Please (a) identify the product that is involved, the date and place of purchase, order number and the purchase invoice number; (b) describe completely what the claimed defect is (photographs or sketches

useful); c) if any, state what attempts have been made to correct the problem and by whom; d) give the address where the defective product can be inspected; and e) give a phone number where you can be reached.

What this Warranty does not Cover

The remedies mentioned herein are valid only when products covered by this warranty are properly installed, finished, and maintained. 64Door Factory will not be liable for:

- > Product which has been damaged by an independent shipping contractor
- > Accident, mishandling, or improper use
- > Negligent operation
- > Improper installation or maintenance
- > Fire, flood, earthquake, storm, tornado, acts of nature, or any other cause beyond the control of 64Door Factory

> Any products, components or parts not manufactured by 64Door Factory

> Any defects not as a result of design, manufacturing, or installation by 64Door Factory technicians

> Defects caused by failure to provide a suitable installation environment for the product

> Use of the product for purposes other than those for which it was designed

> Unauthorized modifications/ attachments

> Any other abuse or misuse by the independent shipping contractor, original purchaser or subsequent user.

All disclaimers and exclusions contained herein apply under all conditions. There are additional exclusions which apply to this product contained in the Installation, Care and Maintenance Instructions. If you have not received a copy of the Installation, Care and Maintenance Instructions, please contact the 64Door Factory distributor, exporter, or dealer for a copy of this publication.

Important Legal Information

This Warranty sets forth 64Door maximum liability for its products. 64Door shall not be liable for special, indirect, consequential or incidental damages. Your exclusive remedy with respect to any and all losses or damages resulting from any cause whatsoever shall be as specified above. 64Door shall in no event be liable for any consequential or incidental damages of

any kind, however occasioned, whether by negligence or otherwise. 64Door makes no other warranty or guarantee, either express or implied, including implied warranties of merchantability and fitness for a particular purpose to the original purchaser or to any subsequent user of the product, except as expressly contained herein. The remedies contained herein shall be sole

and exclusive. In the event applicable law precludes exclusion or limitation of implied warranties, the duration of any such warranties shall be no longer than, and the time and manner of presenting any claim thereon shall be the same as, that provided in the express warranty stated herein.

Please complete the details below for your records

Purchase Date: Order Number: Invoice Number:.....